

1# Semi-rigid/flexible Cable	01	Flex405	39
2# Semi-rigid /flexible Cable	04	Flex402	39
3# Semi-rigid/flexible Cable	11	MF Series	41
CXN3506	15	SUCOFLEX Series	48
CXN3507	18	32051	51
CXN3500	21	32055	51
CXN3449	21	SFCJ-50-3-51	52
CXN3508	23	UFB Series	53
CXN3450	23	Microstrip KF (female flange) Series	55
SFF-50-0.6	25	Microstrip KFD (female flange) Series	56
SFF-50-1、RG178	25	Microstrip KYD(female bulkhead) Series	68
SFF-50-1.5-1、RG316	26	Microstrip KHD(female PCB) Series	71
SFF-50-1.5-2	31	Microstrip KWFD(female RA flange) Series	73
SFF-50-2-1	32	Microstrip KWHD(female RA flange) Series	79
SFF-50-2-2	33	Microstrip KYHD(female bulkhead PCB) Series	79
SFF-50-3-1	33	Microstrip KYWHD(female bulkhead RA PCB) Series	81
SFF-50-3-2	35	Microstrip JFD (male flange) Series	82
RG142	35	Microstrip JWFD(male RA flange) Series	87
LMR Series	35	Microstrip JYD (male bulkhead) Series	87
EF Series	37	Microstrip JHD (male PCB) Series	87
		In Series Adapter	88

Microstrip KHD(female PCB) Series

SMA-KHD Series

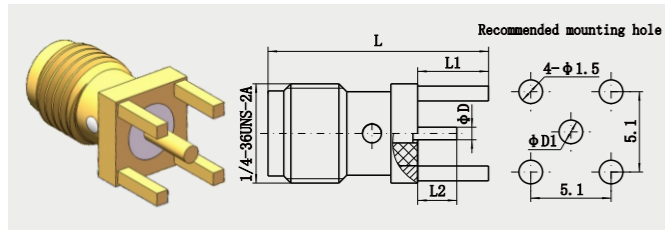

Model No.	L	L1	L2	D	D1	Note
SMA-KHD	13.5	4	4	1.3	1.4	
SMA-KHD109	12	2.5	2.5	1.3	1.4	
SMA-KHD112	12	2.5	1.6	1.3	1.4	
SMA-KHD117	13.5	4	4	0.9	1	
SMA-KHD150	14.5	5	5	1.3	1.4	
SMA-KHD158	15.5	6	6	0.9	1	

SMA-KHD9 Series

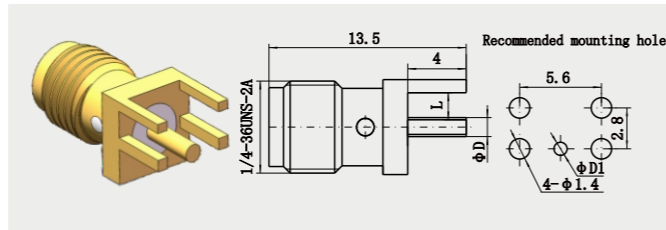

Model No.	L	D	D1	Note
SMA-KHD9	2	1.3	1.4	
SMA-KHD9A	1.8	0.8	0.9	

SMA-KHD2 Series

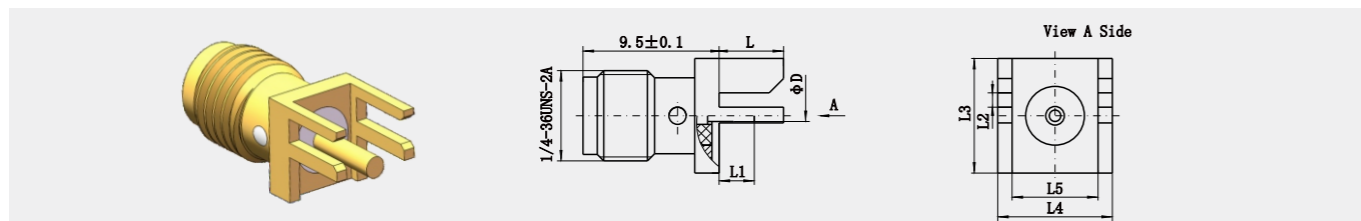

Model No.	L	L1	L2	L3	L4	L5	D	Note
SMA-KHD2	4	4.1max	1.5	6.1	6.1	4.5	1.3	
SMA-KHD3	4	4max	2.2	6.7	6.7	4.7	0.8	
SMA-KHD5	4.5	4.6max	1.6	8	9.5	7.5	0.8	
SMA-KHD12	4	2.5	2.5	6.7	6.7	4.7	0.3	
SMA-KHD16	4.8	4.8max	1.6	8	9.5	7.5	0.8	
SMA-KHD100	4	4max	2	6.7	6.7	4.7	0.8	
SMA-KHD102	4.7	4.6max	1.1	8	9.5	7.5	0.8	
SMA-KHD104	4.5	1.2max	1	8	8	6	0.8	

SMA-KHD19 Series

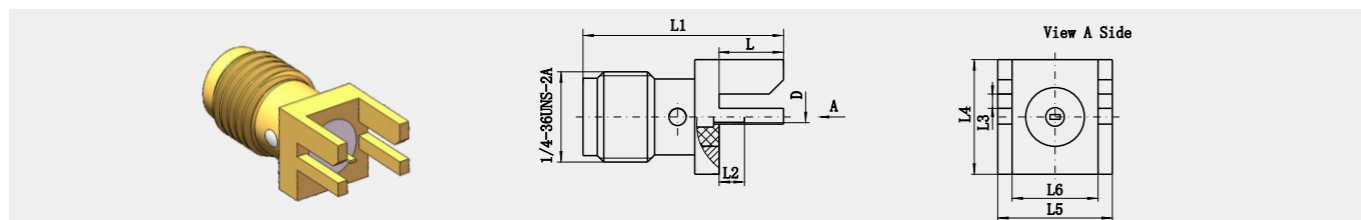

Model No.	L	L1	L2	L3	L4	L5	L6	D	Note
SMA-KHD19	4	13.5	2	1	6.1	6.1	4.5	0.5×0.2	
SMA-KHD101	4.7	14.2	4.7	1.8	8	9.5	7.5	Φ0.4	
SMA-KHD108	4	13.5	2	0.7	6.1	6.1	4.5	0.5×0.2	
SMA-KHD125	4	13.5	2	0.5	6.5	6.5	4.5	0.5×0.2	
SMA-KHD135	3.9	13.5	2	1	6.1	6.1	4.5	Φ0.4	
SMA-KHD151	3.9	13.5	2	1.6	6.1	6.1	4.5	Φ0.4	

Microstrip KHD (female PCB) Series

SMA-KHD103 Series

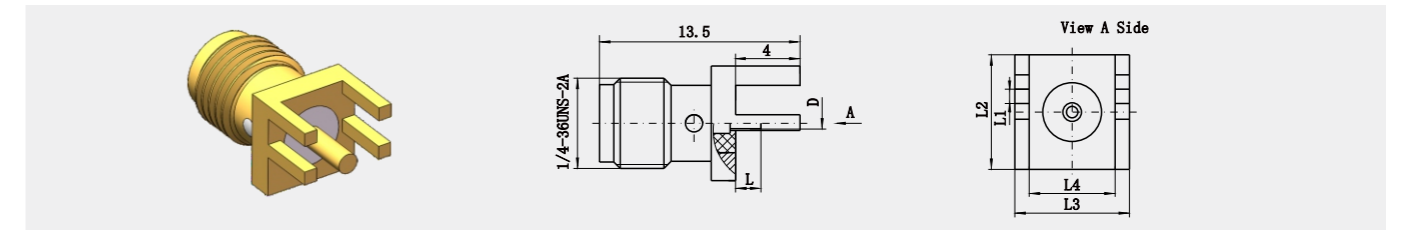

Model No.	L	L1	L2	L3	L4	D	Note
SMA-KHD103	4	1.8	6.5	6.5	4.6	Φ1.3	
SMA-KHD106	2	1.5	6.1	6.1	4.1	0.5×0.2	
SMA-KHD114	2	2	6.1	6.1	4.1	0.5×0.2	
SMA-KHD118	4	1.2	6.1	6.1	4.1	0.5×0.2	

SMA-KHD107

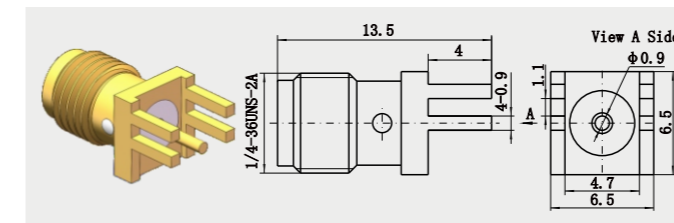

Model No.	Note
SMA-KHD107	

SMA-KHD110

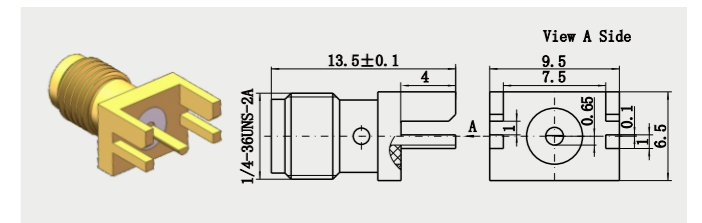

Model No.	Note
SMA-KHD110	

SMA-KHD129

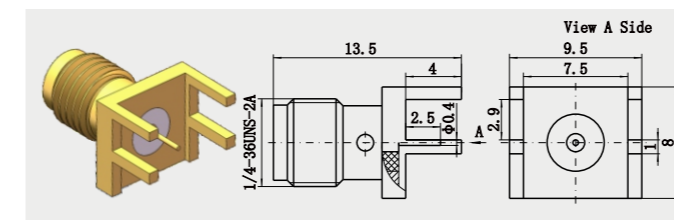

Model No.	Note
SMA-KHD129	

SMA-KHD133

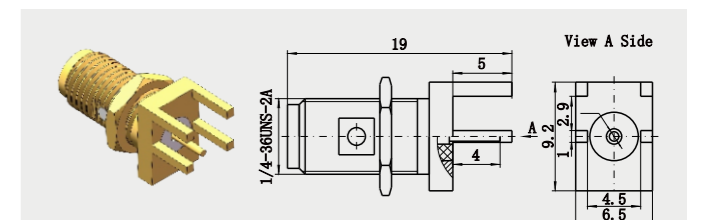

Model No.	Note
SMA-KHD133	

SMA-KHD143

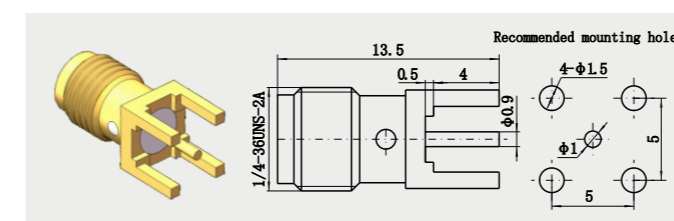

Model No.	Note
SMA-KHD143	

Microstrip KWHD (female RA PCB) Series

SMA-KWHD

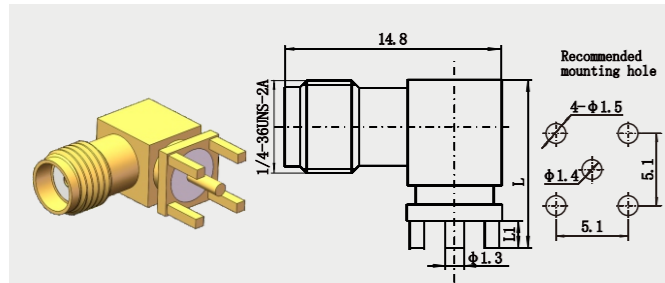

Model No.	L	L1	Note
SMA-KWHD	13.5	3.9	
SMA-KWHD9	11.5	1.9	
SMA-KWHD11	15.6	6	

SMA-KWHD1

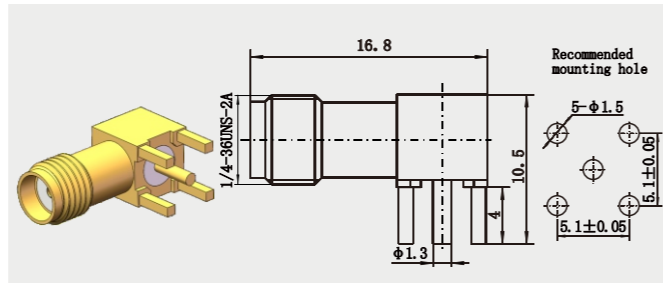

Model No.	Note
SMA-KWHD1	

SMA-KWHD2

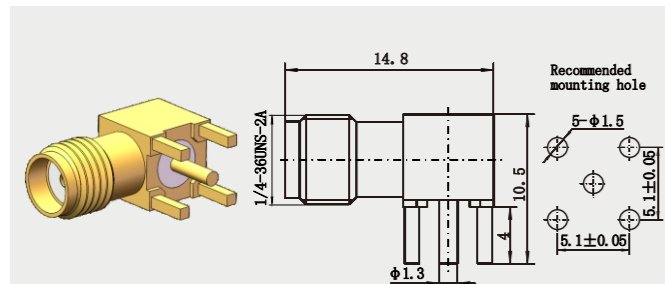

Model No.	Note
SMA-KWHD2	

SMA-KWHD5

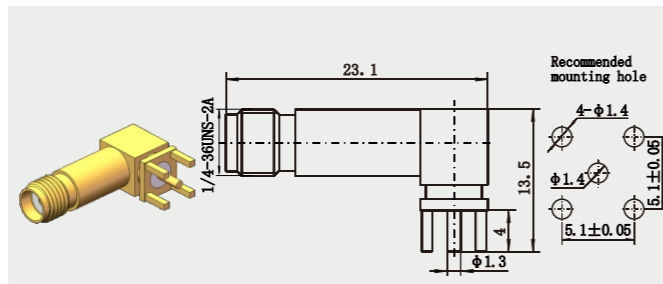

Model No.	Note
SMA-KWHD5	

Microstrip KYHD (female bulkhead PCB) Series

SMA-KYHD

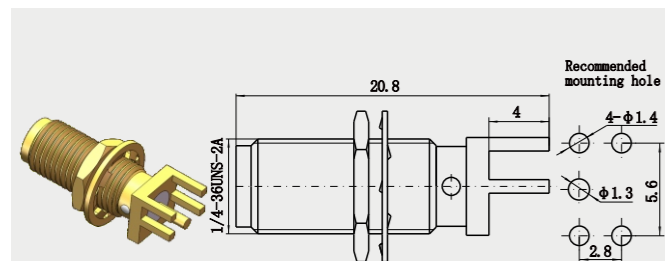

Model No.	Note
SMA-KYHD	

SMA-KYHDT

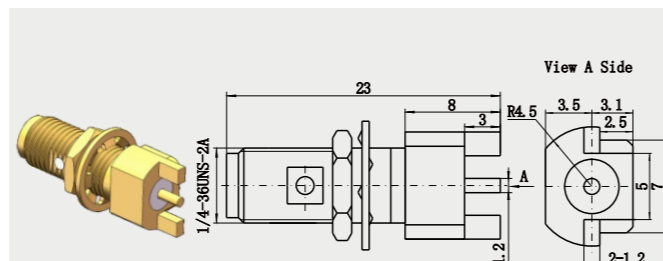

Model No.	Note
SMA-KYHDT	

Microstrip KYHD (female bulkhead PCB) Series

SMA-KYHD1

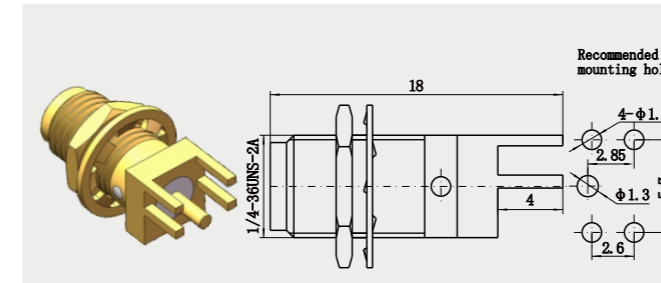

Model No.	Note
SMA-KYHD1	

SMA-KYHD4 Series

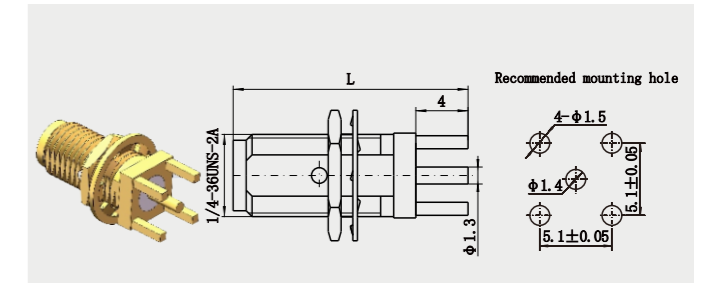

Model No.	L	Note
SMA-KYHD4	18	
SMA-KYHD6	27	
SMA-KYHD6N	27	Nickel plated copper shell

SMA-KYHD2 Series

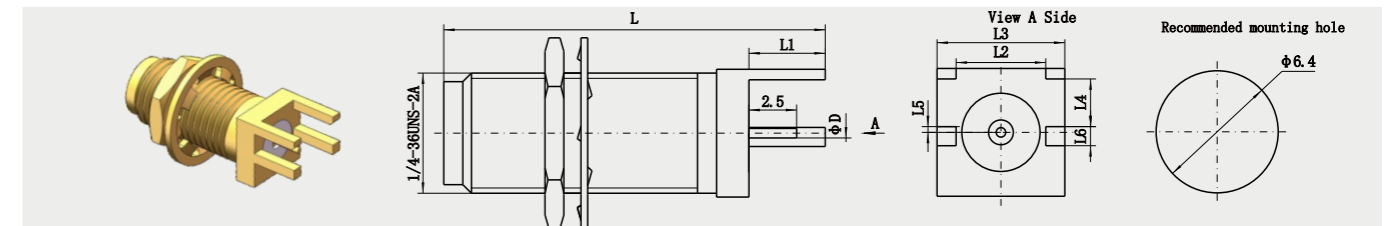

Model No.	L	L1	L2	L3	L4	L5	L6	D	Note
SMA-KYHD2	19.5	4.5	4.5	6.5	2	0.3	1	0.5	
SMA-KYHD5	20	4	4.7	6.7	2.5	0.35	1	0.5	
SMA-KYHD10	17	4	4.5	6.5	1	0.4	0.85	1	
SMA-KYHD105	23	4	4.5	6.5	1	0.4	0.85	1	

SMA-KYHD7

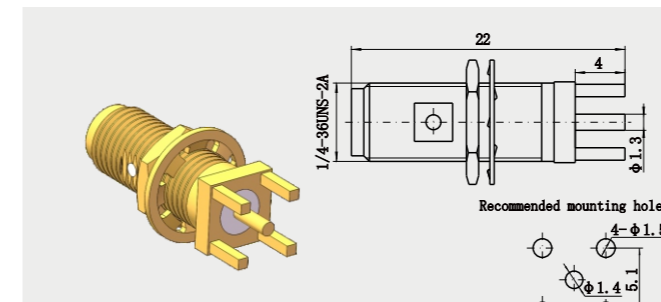

Model No.	Note
SMA-KYHD7	

SMA-KYHD11 Series

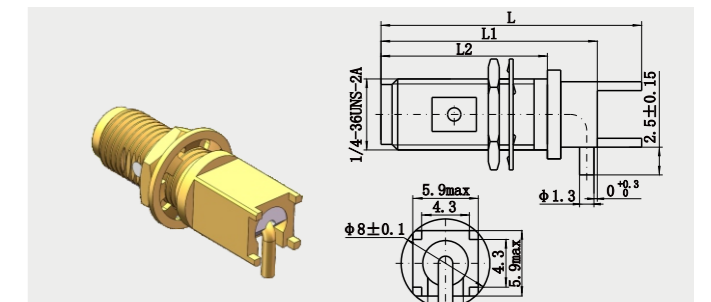

Model No.	L	L1	L2	Note
SMA-KYHD11	23.5	22.5	13.5	
SMA-KYHD16	20.5	19.5	15	
SMA-KYHD17	23.4	19.5	15	

Microstrip KYWHD (female bulkhead RA PCB) Series

SMA-KYWHD Series

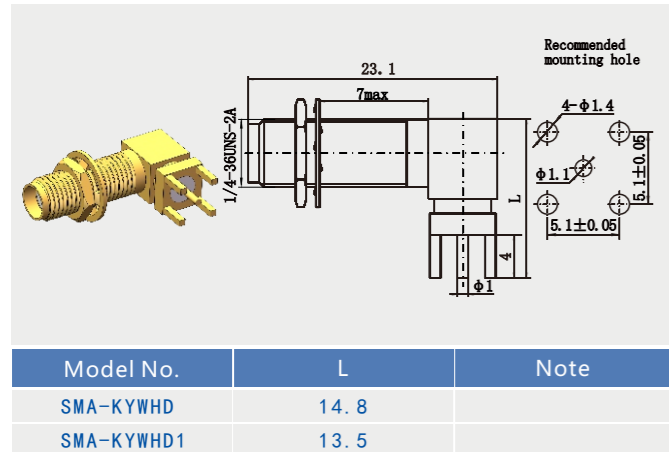

SMA-KYWHD2

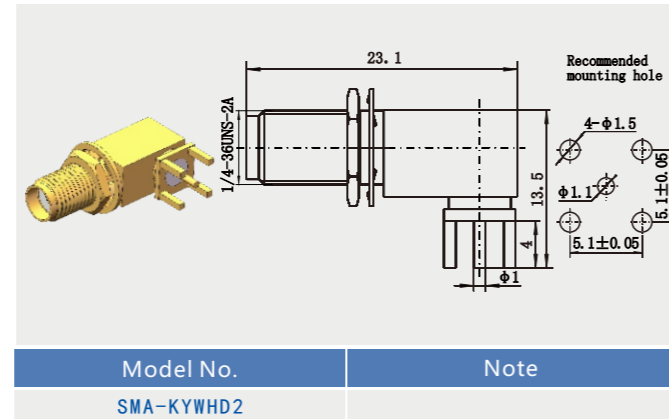

SMA-KYWHD4

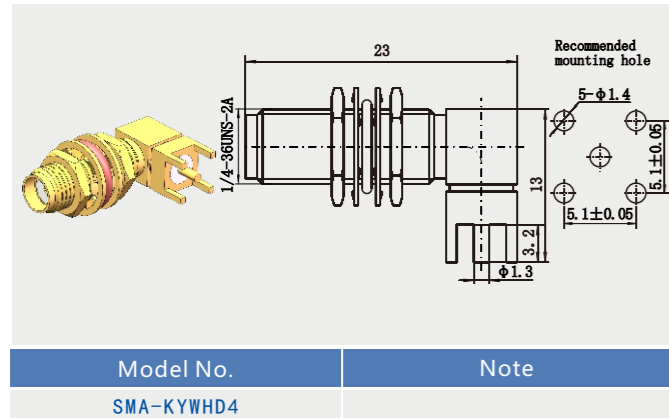

Microstrip JFD (male flange) Series

SMA-JFD2 Series

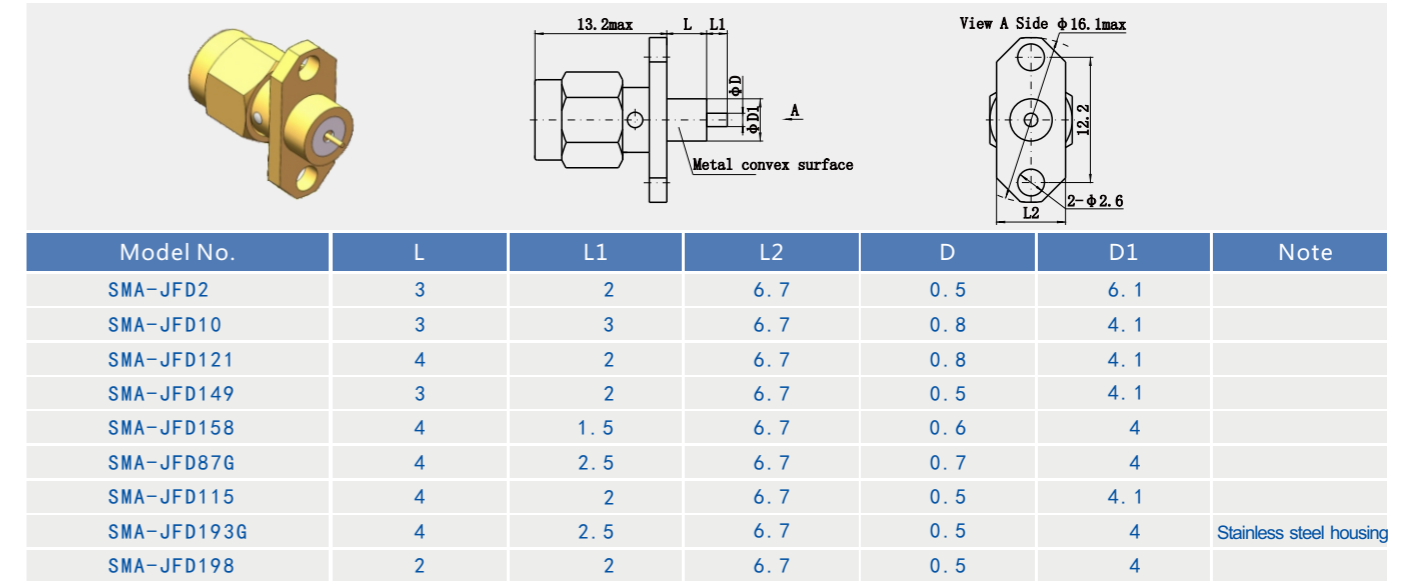

SMA-JFD9 Series

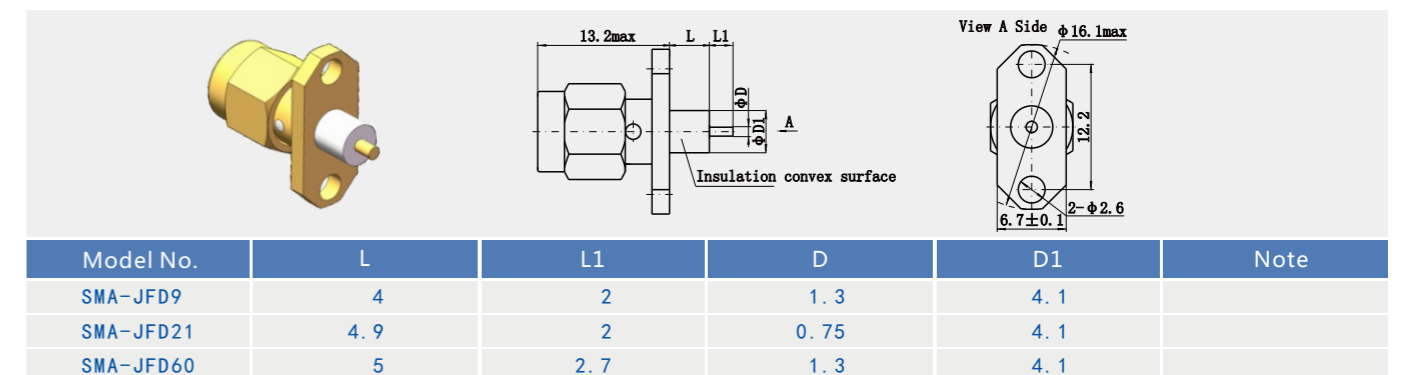

SMA-JFD11

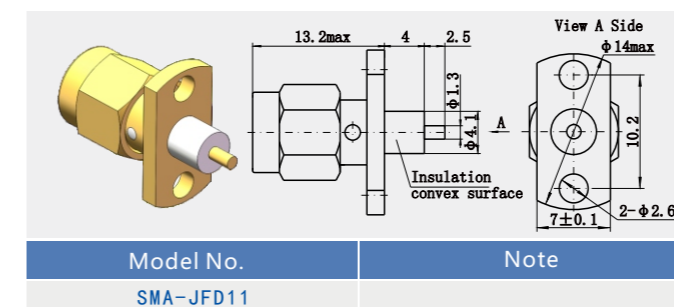

SMA-JFD153G Series

